

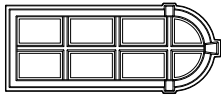

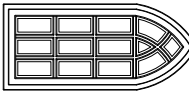
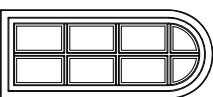
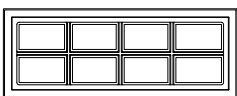

Cupola Data
 Overall Height = 11' 10 3/16"
 Base Width = 6'
 Unit Weight = 800 lbs.

Optional Window Panels

- 310  Keystone
- 303  Venetian
- 309  Round Top
- 301  Squared

Note: Windows also available without panes.

Optional Cupola Finials

-  36" Cross
-  8"Ø Sphere
-  36" Aluminum Spire
-  8"Ø Sphere

Weather/vane selection at:
www.whitehallproducts.com

Base Panels: WPK comes standard with 8 K-glass windows. See above for optional window designs.

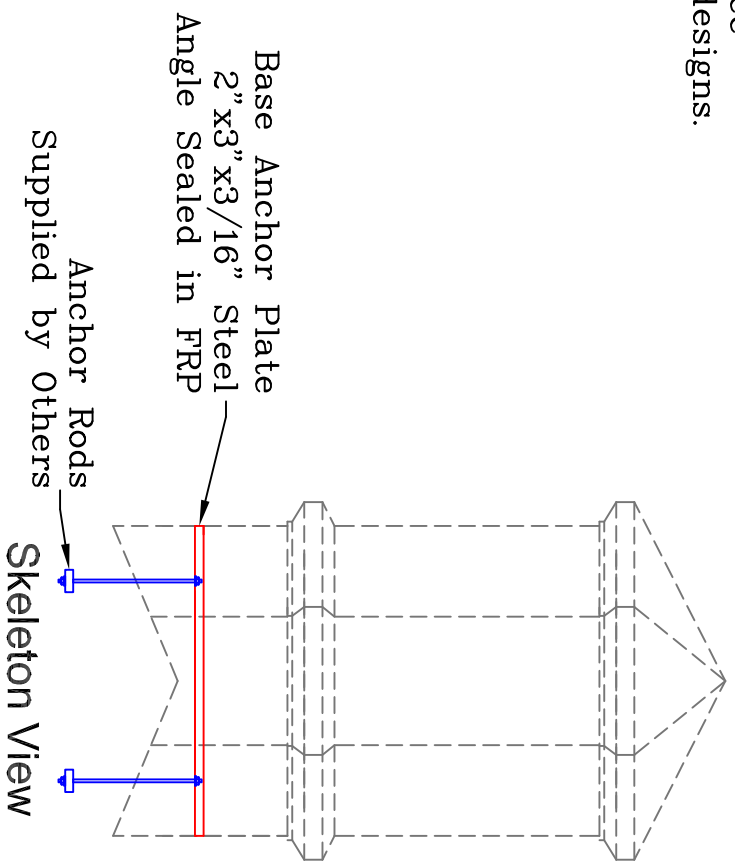
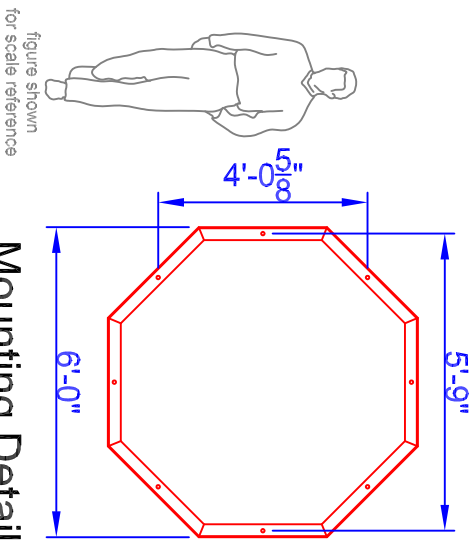
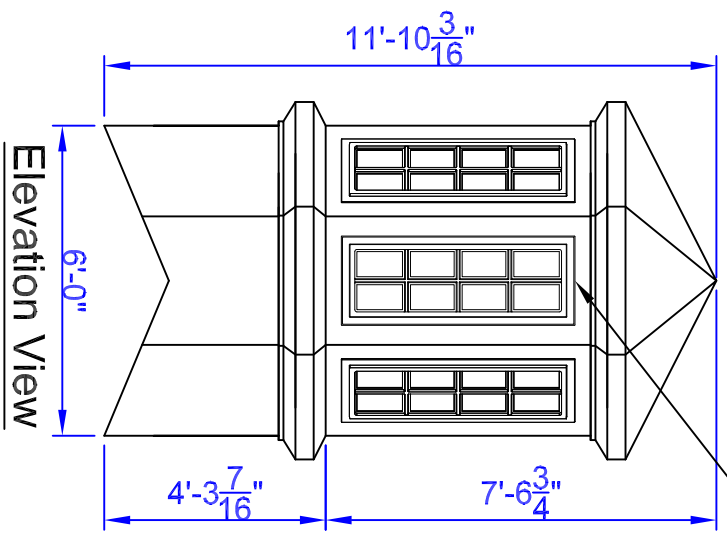

Note: All drawings are the property of Piedmont Fiberglass. Dimensions & designs may be altered to accommodate manufacturing.



Piedmont Fiberglass Inc.
 PO Box 1089
 Taylorsville, NC 28681
 Phone: 828-632-8883
 Fax: 828-632-5585
www.piedmontfiberglass.com

Cupola

Model: **600-WPK**

Scale: **scale**
 Drawn By: **TJD/JEM**
 Created On: **2/12/07**
 Updated On: **11/9/10**